



- **COMPACT & LIGHTWEIGHT PACKAGE**
- **UNIVERSAL/POWER FACTOR CORRECTED INPUT**
- **LOW COST MODULAR OEM PLATFORM**
- **ADVANCED RESONANT SOFT SWITCHING INVERTER TOPOLOGY**
- **RoHS COMPLIANT**

Spellman's CCM1KW capacitor charging module is designed to provide up to 1000 Joules per second at an output voltage up to 4000 Volts. The power factor corrected AC input, small package size and both a comprehensive and minimal analog interface simplifies integrating the CCM1KW into your OEM system design. Available in either positive or negative polarity, the CCM1KW is fully arc, open and short circuit protected.

TYPICAL APPLICATIONS

UV light sources for curing and sterilization
Industrial and medical laser applications

SPECIFICATIONS

Input Voltage:

90-264 Vac, 47-63 Hertz, power factor corrected input ≥ 0.98

Input Current:

14 Amps worst case, 1000 Joules per second
7 Amps worst case, 500 Joules per second

Efficiency:

$>85\%$

Output Power:

1000 Joules per second, 500 Joules per second

Output Voltage:

0-1kV, 0-2kV and 0-4kV version available

Output Polarity:

Positive or negative, specify at time of order

Stored Energy:

Less than 0.2 Joules

Pulse to Pulse Repeatability:

$\pm 0.2\%$ up to 1kHz

Temperature Coefficient:

≤ 100 ppm per degree C

Fault Diagnostic System:

Over Temperature and Over Voltage
Over Voltage Fault is latched requiring AC power recycle to clear.
Over Temperature Fault is latched but can be cleared via inhibit/fault reset line.

Environmental:

Temperature Range:
Operating: 0°C to 40°C
Storage: -40°C to 85°C
Humidity:
10% to 90% RH, non-condensing

Cooling:

Forced air

Input Line Connector:

2 position Phoenix MSTB connector, straight and right angle mating connector provided

HV Output Connector:

Standard: Kings/Winchester Electronics SHV 1707-1
Optional: Amphenol MHV UG-931/U

Interface-A Connector:

15 pin D, female

Interface-B Connector:

4 pin male Molex 705530038

Ground Stud:

10-32, nut supplied

Dimensions:

3" H X 6" W X 9" D (76.2mm x 152.4mm x 228.6mm)

Mounting:

M4 screw. Max. depth is 0.188" (4.78mm)

Weight:

6.9lb. (3.13kgs)

Regulatory Approvals:

Compliant to 2004/108/EC, The EMC Directive and 2006/95/EC, The Low Voltage Directive, approval pending.
Compliant to 2002/95/EC, RoHS.

AC INPUT-2 POSITION TERMINAL BLOCK

PIN	SIGNAL	SIGNAL PARAMETERS
1	AC Input High/Phase 1	Line Hot/Phase 1
2	AC Input Low/Phase 2	Line Neutral/Phase 2

ANALOG INTERFACE A – 15 PIN FEMALE D CONNECTOR

PIN	SIGNAL	SIGNAL PARAMETERS
1	Inhibit/Fault Reset	Ground = HV Enable, Open/+15Vdc = HV Inhibit
2	N/C	N/C
3	OverTemp Fault	No OT Fault = +15Vdc @ 3mA, OT Fault = Ground
4	Signal Ground	Signal Ground (optional)*
5	Voltage Program	0 to 10Vdc = 0 to 100% rated output voltage
6	Overvoltage Status	No OVP = +15Vdc @ 3mA, OVP Fault = Ground
7	Peak Hold Monitor	Peak output voltage displayed, 0 to 10Vdc = 0 to 100% rated output voltage with a 5 second time constant
8	Voltage Monitor	0 to 10Vdc = 0 to 100% rated output voltage, ±1%
9	+15Vdc	+15Vdc @ 150mA, maximum
10	N/C	N/C
11	+15Vdc	+15Vdc @ 150mA, maximum (optional)*
12	Signal Ground	Signal Ground (optional)*
13	End of Charge	Charging = +15Vdc @ 1.5mA, End of Charge = Ground
14	Signal Ground	Signal Ground
15	Signal Ground	Signal Ground

Note: Output status signals are NMOS transistor controlled, 100mA maximum sink current. Actual signals are 5kΩ pull ups to the internal +15Vdc logic source.

*Optional interface signals can be provided to be compatible with other pre-existing legacy interfaces. On standard units these signals are N/C.

TYPICAL GRAPH FOR CCM1P1000

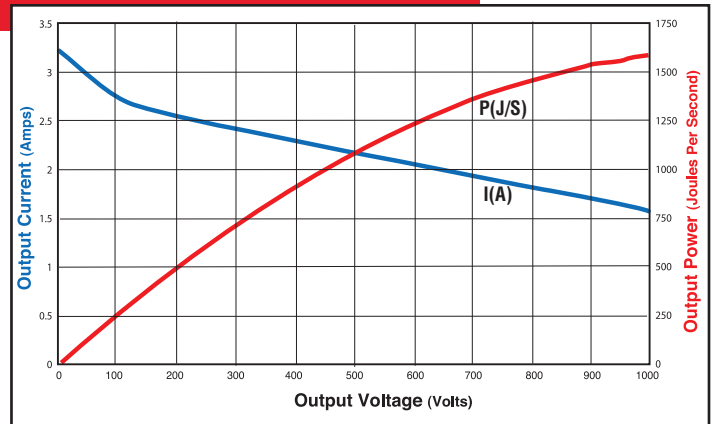

By utilizing a unique inverter topology, a reduction in peak power is achieved for the same average output power

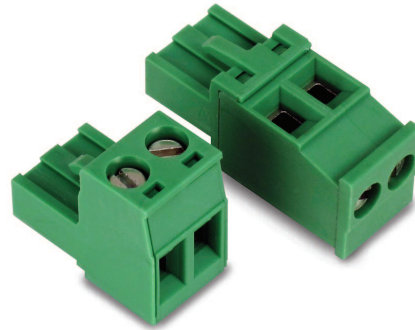

Straight and right angle AC input mating connectors are provided

INTERFACE B-4 PIN MALE D HEADER

PIN	SIGNAL	SIGNAL PARAMETERS
1	Inhibit/Fault Reset	Ground = HV Enable, Open/+15Vdc = HV Inhibit
2	Signal Ground	Signal Ground
3	Voltage Program	0 to 10Vdc = 0 to 100% rated output voltage
4	+15Vdc	+15Vdc @ 150mA, maximum (optional)*

OPTION ORDERING INFORMATION

OPTION	OPTION CODE
MHV UG-931/U HV Connector	MVH
Legacy Interface Signals	L

CCM1KW SELECTION TABLE

kV	JOULES/SECOND	MODEL
1	500	CCM1*500
2	500	CCM2*500
4	500	CCM4*500
1	1000	CCM1*1000
2	1000	CCM2*1000
4	1000	CCM4*1000

*Specify P for positive or N for negative

500 J/s units have a single internal fan, 1000 J/s units have both an internal and external fan.

OPTION ORDERING EXAMPLE

CCM4P1000/MHV

Model | Voltage | Polarity | J/S | Option

500 Joules per second
(unit with internal fan)
DIMENSIONS: in.[mm]

REAR VIEW

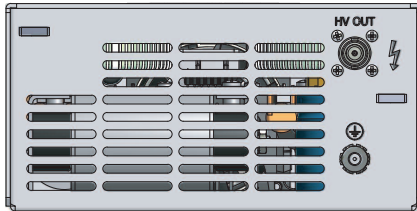

FRONT VIEW

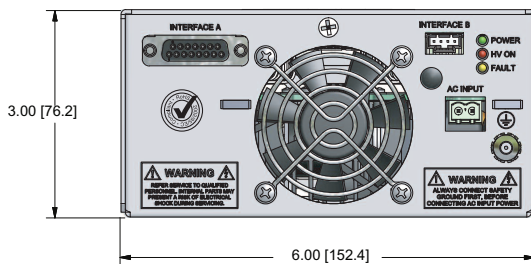

BOTTOM VIEW

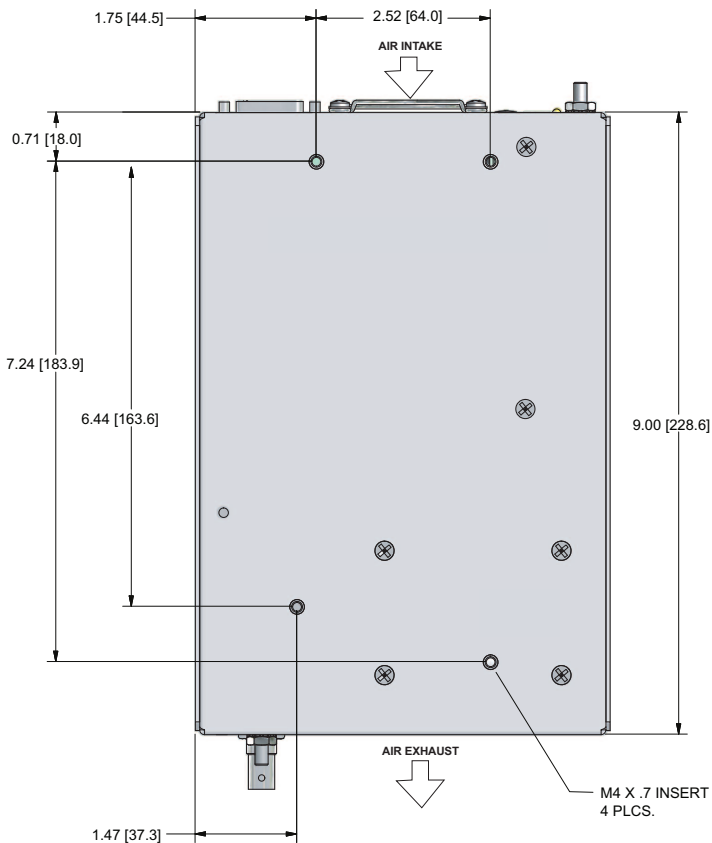

1000 Joules per second
(unit with internal and external fan)
DIMENSIONS: in.[mm]

REAR VIEW

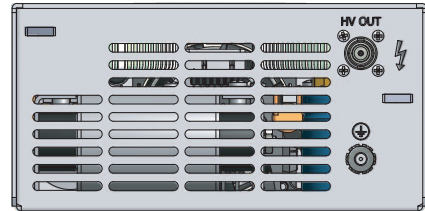

FRONT VIEW

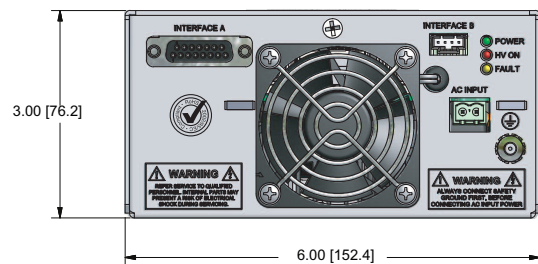

BOTTOM VIEW

